

Energy Management Modular DC Energy analyzer Type VIM-E and VIM-X



- Modular solution based on the combination of two units: VIM-E analysis unit and VIM-X universal power supply and RS485 communication unit.

VIM-E, DC energy analysis unit



- Instantaneous variables: V, A, W
- Instantaneous variables data format: 4-DGTs
- Energy measurements: kWh
- Energies data format: 6 DGT
- Accuracy: class 1 (kWh), ± 0.5 RDG (current/voltage)
- Direct DC current measurement up to 20A
- External shunt DC current measurement up to 1000A
- Direct DC voltage measurement up to 400V
- Auxiliary power supply from VIM-X unit
- Dimensions: 1-DIN module
- Protection degree (front): IP40

VIM-E Product Description

DC energy analyzer unit with built-in 6 digit display and programming push-button, particularly indicated for DC current, voltage, power and energy metering. Direct connection up to 20A and with external shunt up to 1000A. Moreover the unit is provid-

ed with an auxiliary serial communication bus which is connected to the VIM-X unit so to provide an RS485 communication port. Housing for DIN-rail mounting, IP40 (front) protection degree.

How to order

VIM-E AV00 XX X X

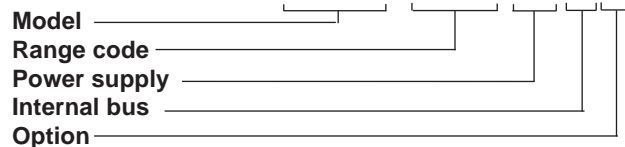

Type Selection

Range code	Power supply	Internal bus	Option
AV00: 400V DC - 20A (Direct connection) or external shunt input for currents up to 1000A (*)	XX: self-power supply from VIM-X unit	X: internal bus compatible only to VIM-X module (*)	X: none

(*) as standard.

VIM-X, universal power supply and RS485 communication unit or static digital output



- Power supply module for VIM-E unit
- RS485 communication port (Modbus)
- One digital output for pulse retransmission proportional to the energy being measured or for alarm control
- 38 to 265 VAC/DC power supply input
- Dimensions: 1-DIN module
- Protection degree (front): IP40

VIM-X Product Description

Universal power supply module suitable to be used in combination to VIM-E unit. In order to improve the communication capability of VIM-E unit, VIM-X can be

provided with either an RS485 communication port or with a static output. Housing for DIN-rail mounting, IP40 (front) protection degree.

How to order

VIM-X U S1 X

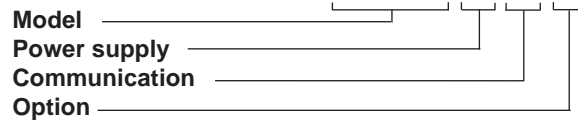

Type Selection

Power supply	Communication	Option	(*) as standard.
U: from 38 to 265VAC/DC (*)	S1: RS485 Modbus(*) D1: static digital output for pulse retransmission or alarm control (*)	X: none	

VIM-E Display and LED specifications

Display Type Information read-out	1 line (max: 6-DGT) LCD, h 7mm From 4 to 6-DGT depending on the information.	priority on any other condition: energy consumption or communication). Green blinking light: the communication on the RS485 bus is working. Note: in case of energy counting or communication condition, the LED alternates its colour from red to green.
LED Type Status and colour	Dual colour Red blinking light: energy consumption; 1000 pulses/kWh (Max Frequency 16 Hz). Red steady light: alarm detected (it has the	

VIM-X LED specification

LED Type	Single colour	Colour	Green: the power supply is ON.
--------------------	---------------	--------	--------------------------------

VIM-E input specifications

Rated inputs Current input Current direct conn. range Current external shunt conn. range Voltage range	1 (internal shunt) From 0 to 20A DC From 0 to 120mV DC From 0 to 400V DC	Max. and Min. indication	See "VIM-E set of variables"
Accuracy Current direct conn. range Start up current Current external shunt conn. Start up current Voltage Start up voltage Power Energy	(@25°C ±5°C, R.H. 60%) ±(0.5%RDG+2 DGT) from 0.05A to 20A DC 50mA DC ±(0.5%RDG+2 DGT) from 0.1mV to 120mV DC 0.1mV DC ±(0.5%RDG+2 DGT) from 1V to 400V DC 10V DC ±(1% RDG+ 2DGT) ±(1% RDG)	Input impedance Voltage Current direct connection Current external shunt conn.	= 5MΩ < 0.006 Ω+ @0.5 Nm (screw terminal torque). > 30kΩ
Temperature drift	≤200ppm/°C	Voltage Overloads Continuous For 1s	500V 800V
Measurement sampling time	≤150 sec	Current Overloads Direct connection Continuous For 1s External shunt connection Continuous For 1s	20A DC 100A DC max 10V DC 20V DC max
Key-pad	1 push-button for variable scrolling and programming of the instrument working parameters.		
Display read-out Instantaneous variables Resolution Energy	4-DGT (V, A, W) 0.1V; 0.01A; 0.01kW (for more details see "VIM-E set of variables") Total: 6-DGT (0.1KWh)		

VIM-X Output specifications

RS485			
Type	Multidrop, bidirectional (static and dynamic variables)	Type	Static: opto-mosfet;
Connections	2-wire. Max. distance 1000m	Load	V _{ON} 2.5 VAC/DC max. 70 mA, V _{OFF} 260 VAC/DC max.
Addresses	247, selectable by means of the front push-button	Pulse output	
Protocol	MODBUS/JBUS (RTU)	Pulse duration	≥100ms < 120msec (ON), ≥120ms (OFF)
Data (bidirectional)		Alarm output	
Dynamic (reading only)	All variables, see table "List of the variables that can be displayed and connected to ..."	Operating mode	With digital output: real alarm; with RS485: virtual alarm.
Static (writing only)	All the configuration parameters.	Alarm modes	Up alarm or down alarm
Data format	1 start bit, 8 data bit, no parity, 1 stop bit	Controlled variables	W, V, A (see the table "List of the variables that can be displayed and connected to ...")
Baud-rate	Selectable: 9600, 19200, 38400, 115200 bits/s	Set-point adjustment	Programmable on all the measuring range (see "VIM-E set of variables")
Parity	Parity: none	Hysteresis	Programmable on all the measuring range (see "VIM-E set of variables")
Driver input capability	1/5 unit load. Maximum 160 transceivers on the same bus.	On-time delay	0 to 9999s (166min)
Special functions	None	Off-time delay	0 to 9999s (166min)
Insulation	See the table "Insulation between inputs and outputs"	Min. response time	≤ 1s, set-point on-time delay: "0 s"
Digital output		Insulation	See the table "Insulation between inputs and outputs"
Number of outputs	1		
Purpose	Selectable either for pulse transmission proportional to the energy being measured or for alarm control on selected variable.		

Main functions

Displaying	1 variable per page. See ("VIM-E set of variables")	Scaling of external shunt current input Input scale Display scale	Programmable from 0 to 120mV DC Programmable from 0 to 1000A DC
Password	Numeric code of max. 4 digits; 2 protection levels of the programming data: Password "0", no protection; Password from 1 to 9999, all data are protected		
1st level 2nd level			
Energy reset	By means of the front push-button		

Insulation between inputs and outputs

Module	Type of input/output	VIM-E				VIM-X		
		Measuring input	Power Supply	RS485 port	Static output			
VIM-E	Measuring input	-	4kV	4kV	4kV			
VIM-X	Power Supply	4kV	-	4kV	4kV			
	RS485 port	4kV	4kV	-	4kV			
	Static output	4kV	4kV	4kV	-			

General specifications

Operating temperature	-25 to +55°C (-13°F to 131°F) (R.H. from 0 to 90% non-condensing @ 40°C)	Immunity to conducted disturbances	EN61000-4-6: 10V from 150KHz to 80MHz;
Storage temperature	-30 to +70°C (-22°F to 158°F) (R.H. < 90% non-condensing @ 40°C)	Surge	EN61000-4-5: 2kV on power supply; 4kV on current inputs.
Installation category	Cat. III (IEC 60664, EN60664)	EMC (Emission) Radio frequency suppression	According to EN61000-6-3 According to CISPR 22
Insulation (for 1 minute)	See table "Insulation between inputs and outputs"	Standard compliance Safety	IEC60664, IEC61010-1 EN60664, EN61010-1
Dielectric strength	4000 VAC RMS for 1 minute	Approvals	CE
Noise rejection CMRR	>65 dB, 45 to 65 Hz	Housing Dimensions (WxHxD) Material	17.5 x 90 x 67 mm Noryl, self-extinguishing: UL 94 V-0
EMC (Immunity) Electrostatic discharges	According to EN61000-6-2 EN61000-4-2: 8kV air discharge, 4kV contact;	Mounting	DIN-rail
Immunity to irradiated Electromagnetic fields	EN61000-4-3: 10V/m from 80 to 3000MHz;	Protection degree Front Screw terminals	IP40 IP20
Immunity to Burst	EN61000-4-4: 4kV on power lines, 2kV on single lines;		

VIM-E connections

Connections Cable cross-section area Current, voltage	Screw-type Min. 2.5 mm ² , max 6 mm ² in case of flexible wire, Max. 10 mm ² in case of rigid wire. Min./Max. screws tightening torque: 0.5 Nm / 1.1 Nm	Screw terminal purposes 6/10 mm ² 1.5 mm ²	4 screw terminals: 1 (+) for current input, 1 (+) for current output 2 (+) external shunt input 2 screw terminals: for negative connection
Current shunt	Max 1.5 mm ² , Min./Max. screws tightening torque: 0.4 Nm / 0.8 Nm	Weight	Approx. 100 g (packing included)

VIM-X connections

Connections Cable cross-section area	Screw-type 1.5 mm ² max. Min./Max. screws tightening torque: 0.4 Nm / 0.8 Nm		nals used for static output, 2 screw terminals used for power supply
Screw terminal purposes 1.5 mm ²	3 screw terminals used for RS485 port. 2 screw terminals used for static output,	Weight	Approx. 100 g (packing included)

VIM-E power supply specifications

Power supply

Self-power supplied

through the VIM-X unit

VIM-X power supply specifications

Power supply

38 to 265 VAC/DC

Power consumption

1.5W, 3VA (VIM-X + VIM-E)

VIM-E set of variables

No.	Variables	Display read-out	Notes
1	V	0.0 to 999.9	
2	A	0.0 to 20.00	In case of external shunt input: 0.0 to 999.9
3	kW	0.0 to 99.99	In case of external shunt input: 0.0 to 999.9
4	kWh	0.0 to 99999.9	In case of external shunt input: 0.0 to 999999

List of the variables that can be displayed and connected to ...

- RS485 communication port
- Alarms

No	Variable	Display	RS485	Alarm	Reset	Notes
1	V	Yes	Yes	Yes	No	
2	V min	No	Yes	No	Yes	The value is saved into E ² PROM
3	V max	No	Yes	No	Yes	The value is saved into E ² PROM
4	A	Yes	Yes	Yes	No	
5	A min	No	Yes	No	Yes	The value is saved into E ² PROM
6	A max	No	Yes	No	Yes	The value is saved into E ² PROM
7	kW	Yes	Yes	Yes	No	
8	kW min	No	Yes	No	Yes	The value is saved into E ² PROM
9	kW max	No	Yes	No	Yes	The value is saved into E ² PROM
10	kWh	Yes	Yes	No	Yes	The value is saved into E ² PROM
11	Alarm	No	Yes	Yes	No	There is only one alarm which can be linked to the available instantaneous variables

VIM-E connections

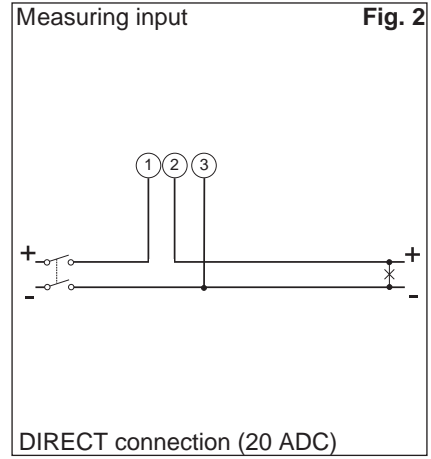
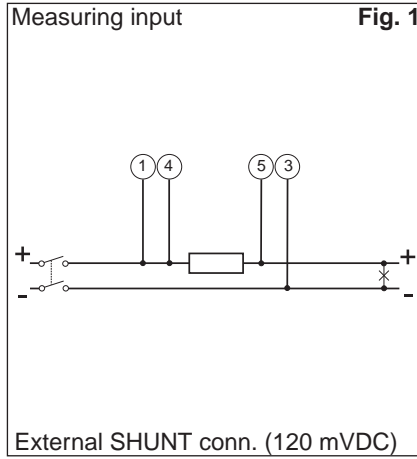
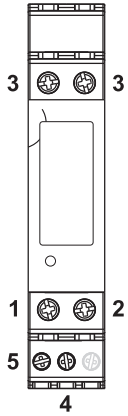

VIM-X connections

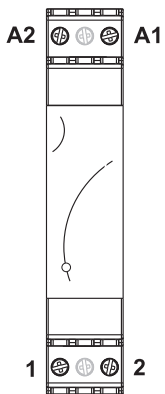

VIM-X D1

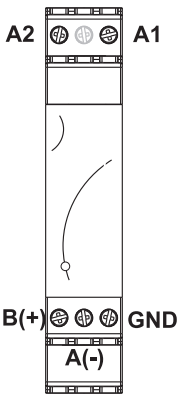
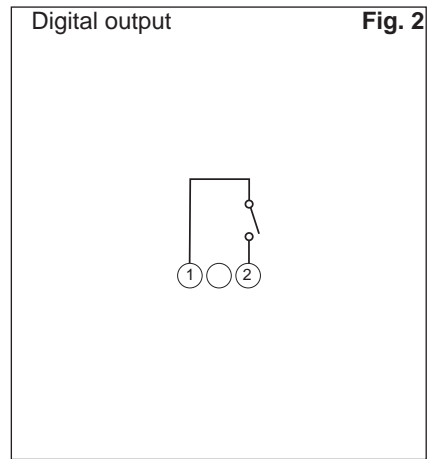
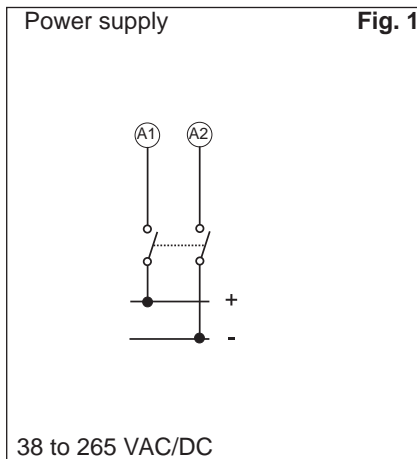

VIM-X S1

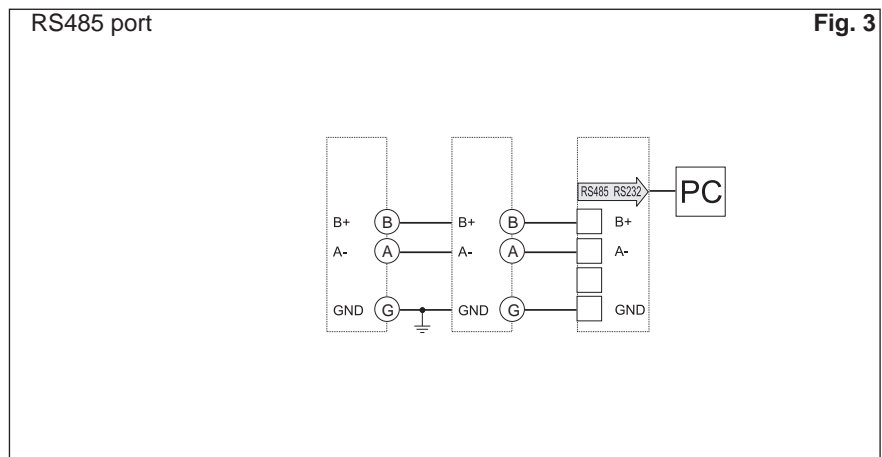

VIM-E Frontal panel description

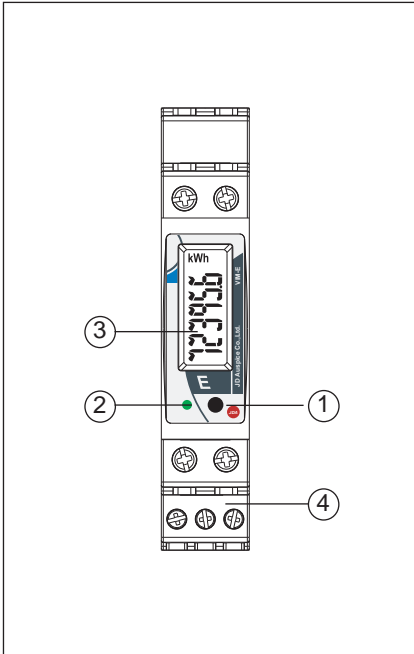

1. Push button.

To program the configuration parameters and to scroll the variables. One key function: short time pushbutton click: variable scroll or parameter increasing. Long time pushbutton click: programming procedure entering, parameter selection confirmation.

2. LED.

Red blinking light: energy consumption; 1000 pulses/kWh (Max Frequency 16 Hz). Red steady light: alarm detected (it has the priority on any other condition: energy consumption or communication). Green blinking light: the communication on the RS485 bus is working. Note: in case of energy counting or communication condition, the LED alternates its colour from red to green.

3. Display.

LCD-type with alphanumeric indications to:

4. Screw terminals.

For measuring input connections.

VIM-X Frontal panel description

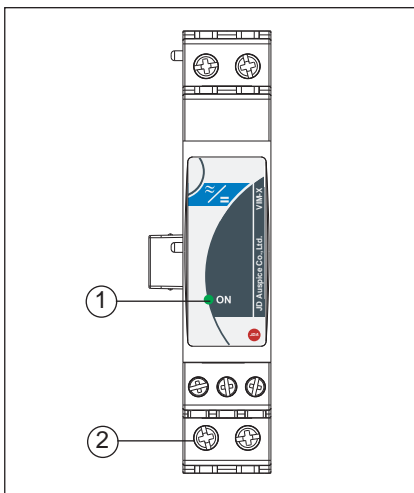

1. LED

Green: the power supply is ON.

2. Screw terminals

For power supply and either digital output or communication port connections.

VIM-E Dimensions and panel cut-out

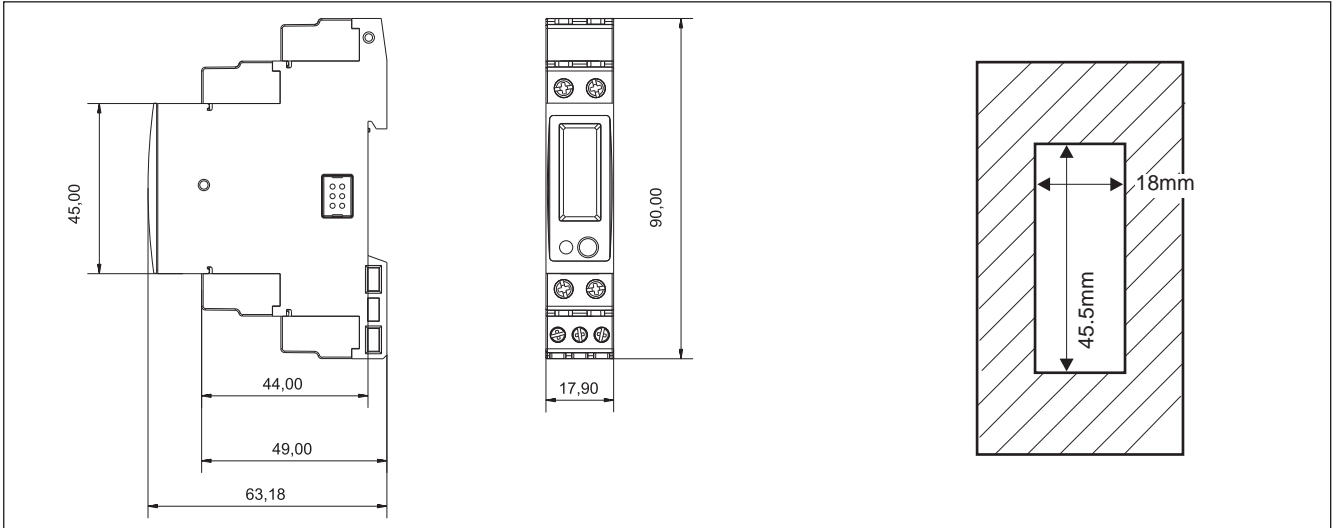

VIM-X Dimensions and panel cut-out

